

C. M
C, I
H, D, H
f
NC 1399S

本

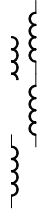

⊥

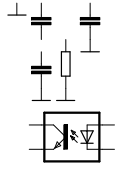

本

本



-

-



—H

—H

—c

—



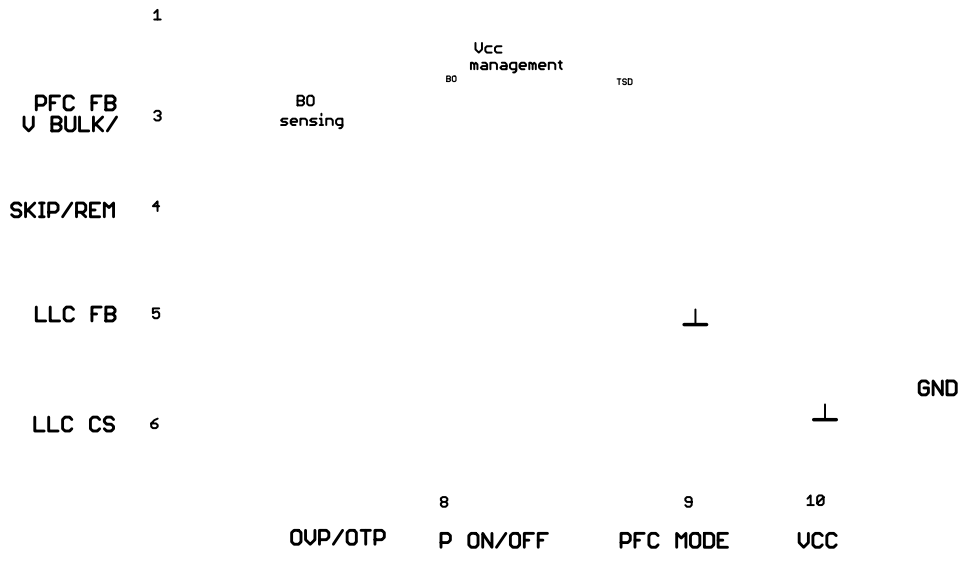

-

| | | | | | | |
|--|--|--|--|--|--|--|
| | | | | | | |
|--|--|--|--|--|--|--|



-



-

| | | | | | | |
|--|--|--|--|--|--|--|
| | | | | | | |
|--|--|--|--|--|--|--|



| | | | | | | |
|--|--|--|--|--|--|--|
| | | | | | | |
|--|--|--|--|--|--|--|

| | | | | | | |
|--|---|---|---|--|---|---|
| | - | - | | | | |
| | - | | - | | - | - |
| | - | | - | | - | - |
| | - | | - | | - | - |
| | - | | | | | |

| | | | | | | |
|--|---|--|--|--|--|---|
| | - | | | | | Ω |
| | | | | | | - |
| | | | | | | |
| | - | | | | | |
| | | | | | | |
| | | | | | | |
| | | | | | | |
| | | | | | | |

-



-

| | | | | | | |
|--|--|--|--|--|--|--|
| | | | | | | |
|--|--|--|--|--|--|--|

| | | | | | | |
|--|--|--|---|--|---|--|
| | | | - | | - | |
| | | | - | | - | |
| | | | - | | - | |
| | | | - | | - | |

| | | | | | | |
|--|--|--|---|---|--|---|
| | | | | | | μ |
| | | | - | - | | |

| | | | | | | |
|--|---|--|---|---|--|---|
| | - | | - | - | | |
| | | | - | - | | μ |
| | | | | | | |
| | | | | | | |
| | - | | | | | |

-

| | | | | | | |
|---|---|---|---|--|---|---|
| | | - | | | | |
| | | - | | | | |
| | | - | | | | |
| | | - | - | | - | - |
| | | | | | | |
| | | - | - | | - | - |
| | | | | | | |
| - | - | - | | | | |
| | - | - | | | | |

-

| | | | | | | |
|--|---|---|--|--|--|--|
| | - | - | | | | |
|--|---|---|--|--|--|--|

Ω

Ω



-







- -





- - -



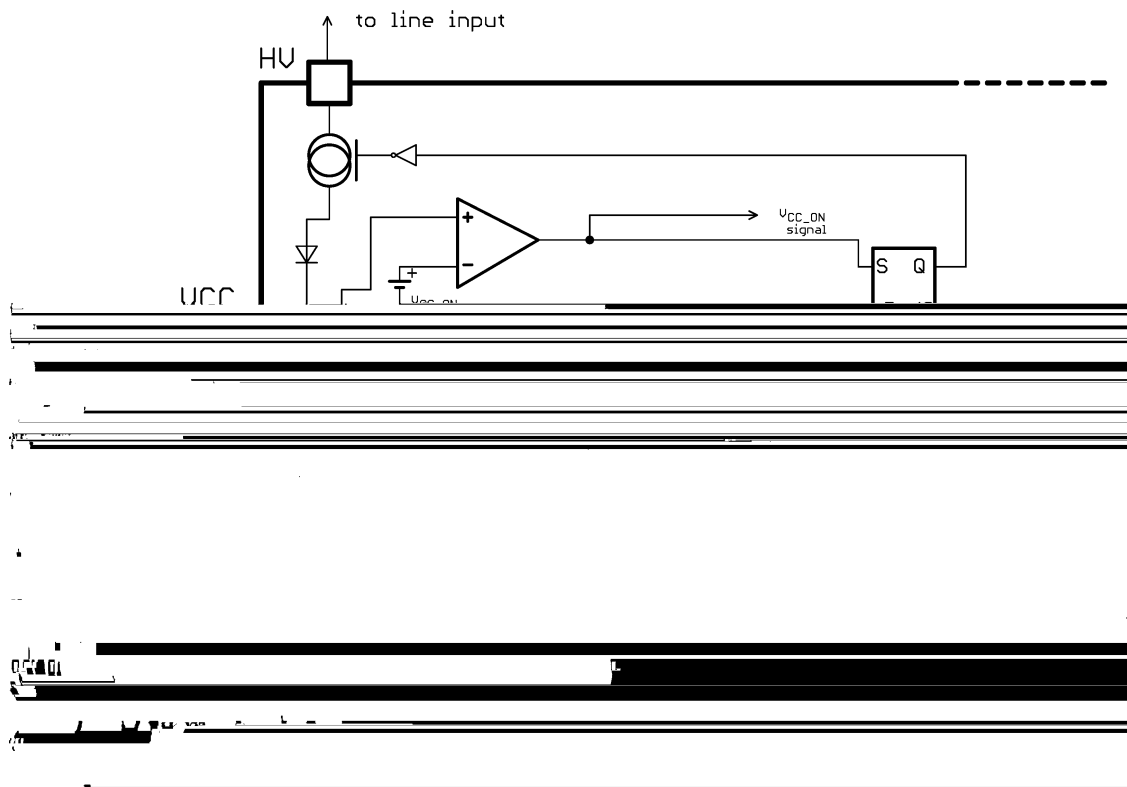

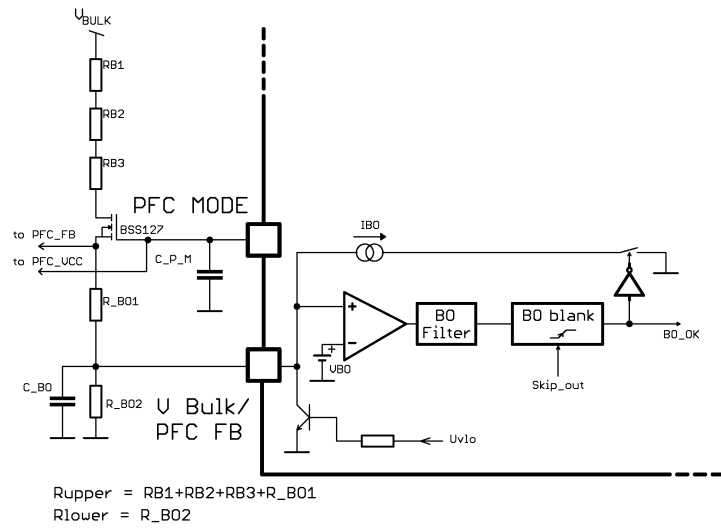

-

-

-





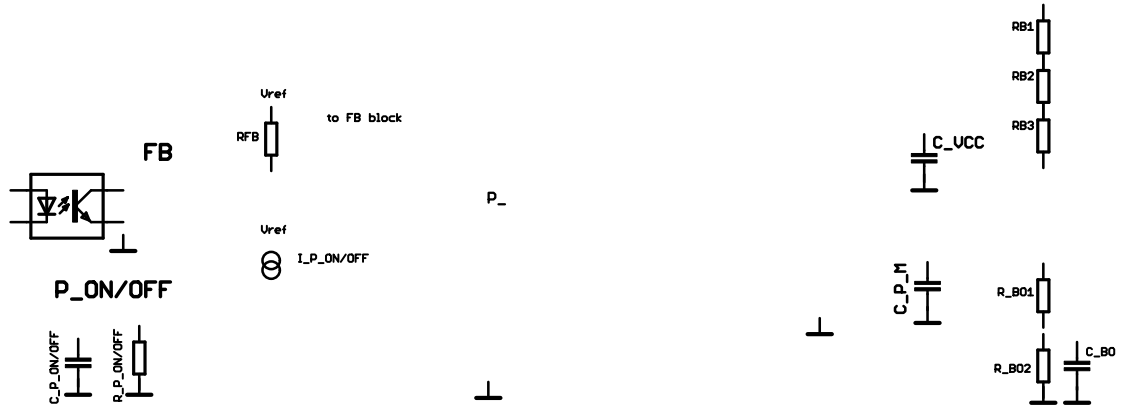

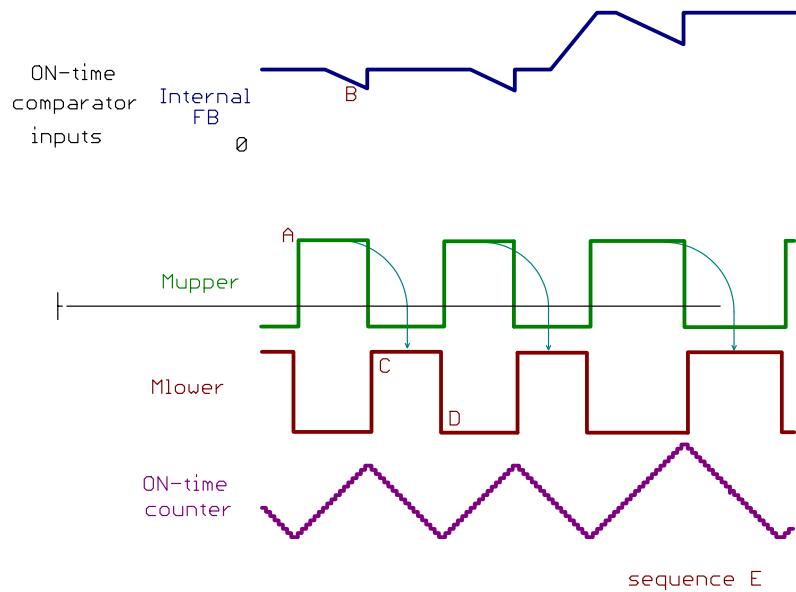

-

μ

μ

Uref to ON-time Skip D_ON/OFF comparators

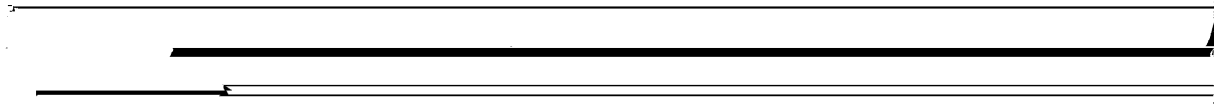

//



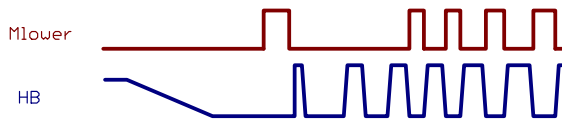
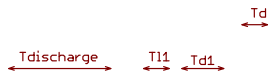
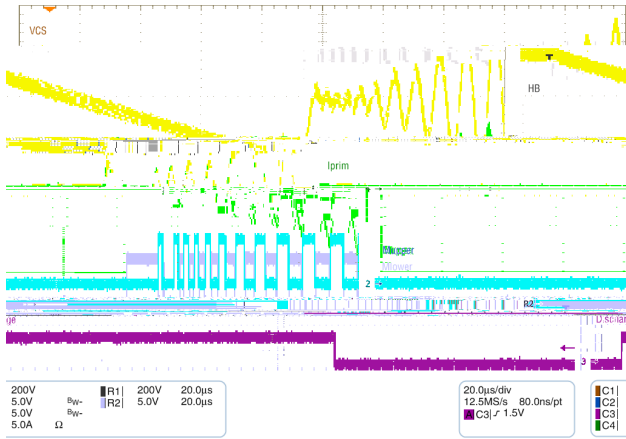



Soft-Start counter

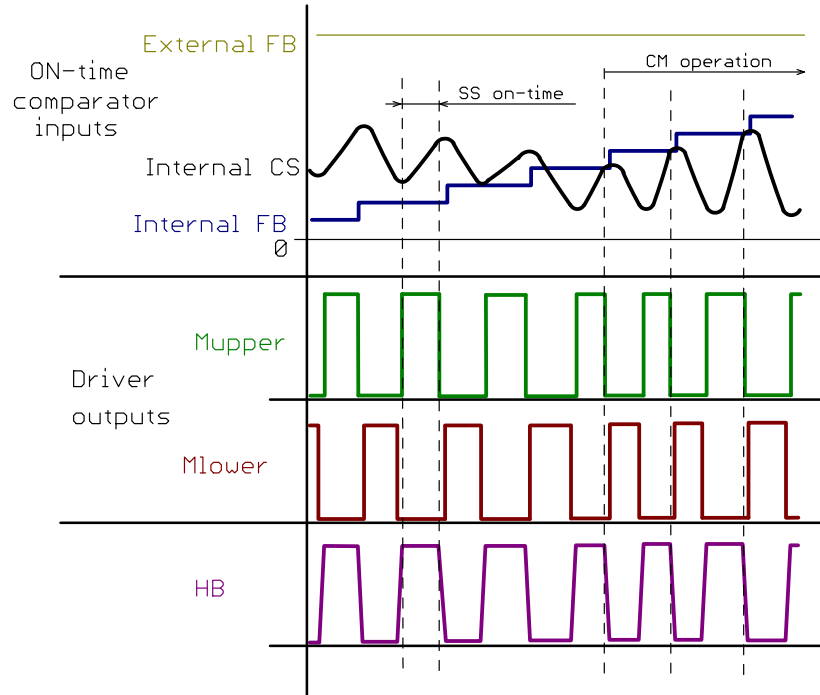

-



M

HB

$V_{HB} < 1/2U_{Bulk}$



-

-



No pulse
Skip mode ← Normal operation

No pulse
Skip mode → Normal operation

|

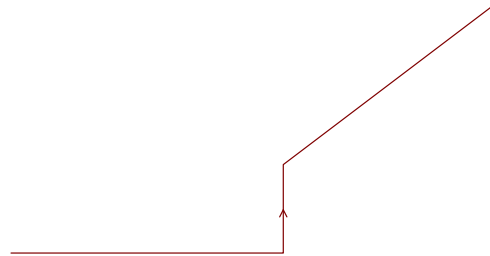

-



-



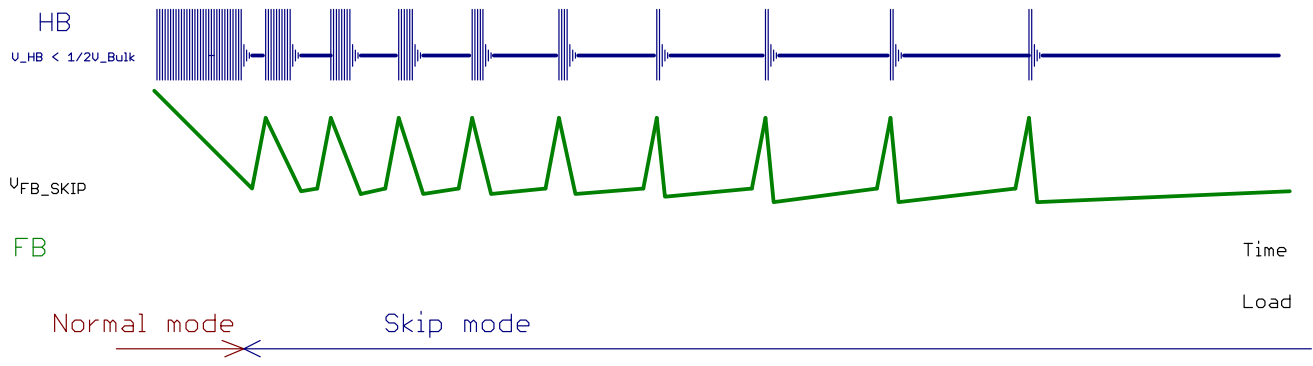

-

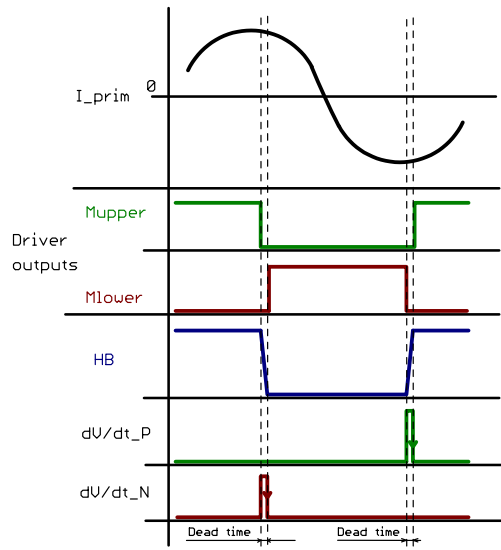

-



-

A

B

C



C

C D

D

E

F;

—

—————

—————

H

I

G

-

-

-

-

H

A

D

E

I

F

J



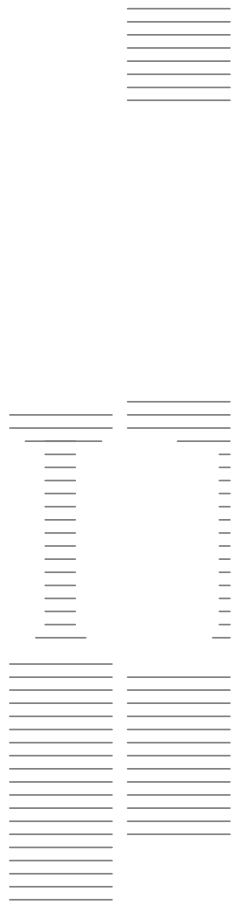

-



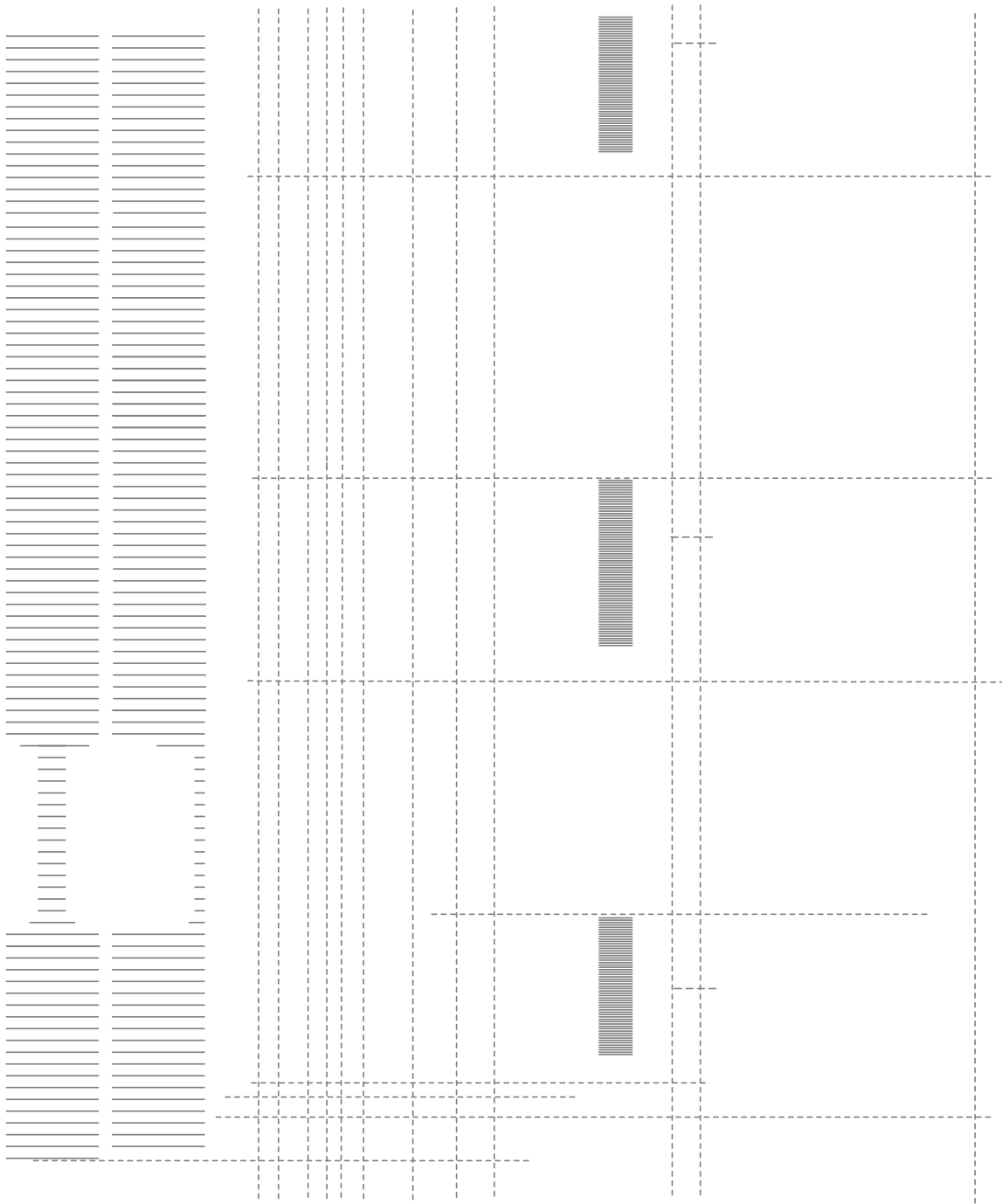

- -





-



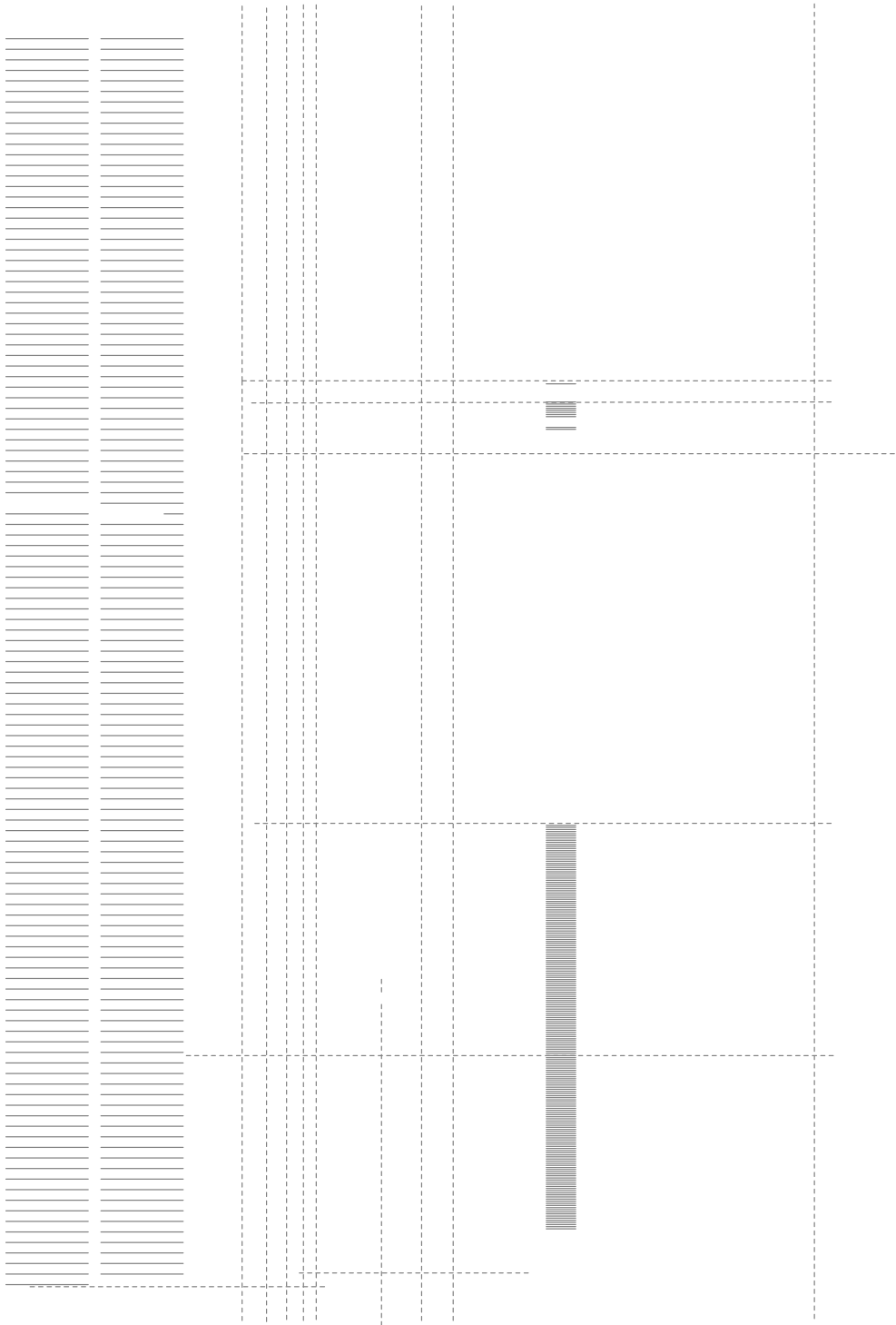

- - - -

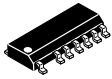

SCALE 1:1

SOIC-16 NB MISSING PINS 2 AND 13
CASE 751DU
ISSUE O

DATE 18 OCT 2013

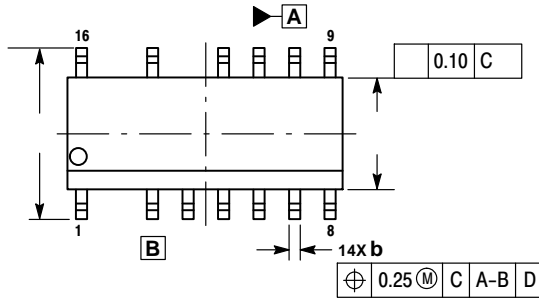

DETAIL A

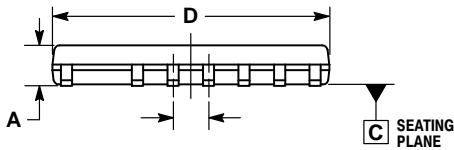

NOTES:

1. DIMENSIONING AND TOLERANCING PER ASME Y14.5M, 1994.
2. CONTROLLING DIMENSION: MILLIMETERS.
3. DIMENSION b DOES NOT INCLUDE DAMBAR PROTRUSION. ALLOWABLE PROTRUSION SHALL BE 0.10 mm IN EXCESS OF MAXIMUM MATERIAL CONDITION.
4. DIMENSIONS D AND E DO NOT INCLUDE MOLD FLASH, PROTRUSIONS OR GATE BURRS. MOLD FLASH, PROTRUSIONS OR GATE BURRS SHALL NOT EXCEED 0.25 mm PER SIDE. DIMENSIONS D AND E ARE DETERMINED AT DATUM F.
5. DIMENSIONS A AND B ARE TO BE DETERMINED AT DATUM F.
6. A1 IS DEFINED AS THE VERTICAL DISTANCE FROM THE SEATING PLANE TO THE LOWEST POINT ON THE PACKAGE BODY.

| DIM | MILLIMETERS | |
|-----|-------------|-------|
| | MIN | MAX |
| A | 1.35 | 1.75 |
| A1 | 0.10 | 0.25 |
| b | 0.35 | 0.49 |
| c | 0.17 | 0.25 |
| D | 9.80 | 10.00 |

| | |
|----|-----------|
| e | 1.27 BSC |
| L | 0.40 1.27 |
| L2 | |

SOLDERING FOOTPRINT

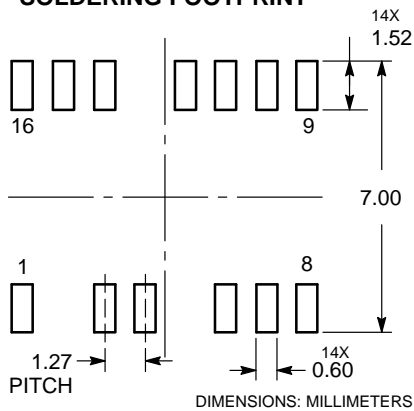

XXXXX = Specific Device Code

onsemi, **onsemi**, and other names, marks, and brands are registered and/or common law trademarks of Semiconductor Components Industries, LLC dba "**onsemi**" or its affiliates and/or subsidiaries in the United States and/or other countries. **onsemi** owns the rights to a number of patents, trademarks, copyrights, trade secrets, and other intellectual property. A listing of **onsemi**'s product/patent coverage may be accessed at www.onsemi.com/site/pdf/Patent-Marking.pdf. **onsemi** reserves the right to make changes at any time to any products or information herein, without notice. The information herein is provided "as-is" and **onsemi** makes no warranty, representation or guarantee regarding the accuracy of the information, product features, availability, functionality, or suitability of its products for any particular purpose, nor does **onsemi** assume any liability arising out of the application or use of any product or circuit, and specifically disclaims any and all liability, including without limitation special, consequential or incidental damages. Buyer is responsible for its products and applications using **onsemi**
