

NCS2554

F -C V D
SD R
F

The NCS2554 is a 4-channel high speed video driver with 6th order Butterworth Reconstruction filters on each channel. A first set of 3-channel has Standard Definition (SD) filters, one per channel. A fourth channel offers an extra filter driver for driving Cvbs-type video signal. The NCS2554 is in fact a combination of a triple SD video driver for YPbPr plus a single Cvbs video driver.

It is designed to be compatible with Digital-to-Analog Converters (DAC) embedded in most video processors.

To further reduce power consumption, 2 enable pins are provided one for the triple driver and another one for the single driver. All channels can accept DC- or AC- 0.2

- Integrated Level Shifter
- AC- or DC-Coupled Inputs and Outputs
- Low Quiescent Current
- Shutdown Current 42 μ A Typical (Disabled)
- Each channel Capable to Drive 2 by 150 Ω Loads
- Wide Operating Supply Voltage Range: +4.7 V to +5.3 V
- Robust ESD protection 8 kV
- TSSOP-14 Package
- This is a Pb-Free Device

Typical Application

- Set Top Box Decoder
- DVD Player / Recorder
- SDTV



<http://onsemi.com>

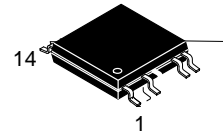

**TSSOP-14
 TBD SUFFIX
 CASE 948G**

MARKING DIAGRAM

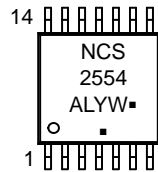

- NCS2554 = Specific Device Code
- A = Assembly Location
- L = Wafer Lot
- Y = Year
- W = Work Week
- = Pb-Free Package

PINOUT

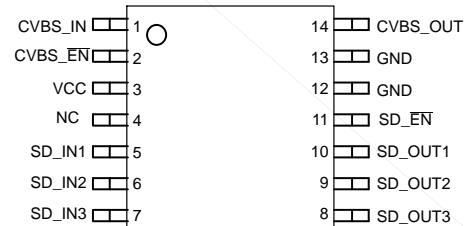

ORDERING INFORMATION

Device	Package	Shipping†
NCS2554DTBR2G	TSSOP-14 (Pb-Free)	2500 / Tape & Reel

†For information on tape and reel specifications, including part orientation and tape sizes, please refer to our Tape and Reel Packaging Specifications Brochure, BRD8011/D.

NCS2554

NCS2554

MAXIMUM RATINGS

Rating	Symbol	Value	Unit
Power Supply Voltages	V_{CC}	$-0.3 \leq V_{CC} \leq 5.5$	Vdc
Input Voltage Range	V_I	$-0.3 \leq V_I \leq V_{CC}$	Vdc
Input Differential Voltage Range	V_{ID}	$-0.3 \leq V_I \leq V_{CC}$	Vdc
Output Current (Indefinitely) per Channel	I_O	40	mA
Maximum Junction Temperature (Note 2)	T_J	150	°C
Operating Ambient Temperature	T_A	-40 to +85	°C
Storage Temperature Range	T_{stg}	-60 to +150	°C
Thermal Resistance, Junction-to-Air	$R_{\theta JA}$	125	°C/W

NCS2554

DC ELECTRICAL CHARACTERISTICS ($V_{CC} = +5.0\text{ V}$, $R_{source} = 37.5\ \Omega$, $T_A = 25^\circ\text{C}$, inputs AC-coupled with $0.1\ \mu\text{F}$, all outputs AC-coupled with $220\ \mu\text{F}$ into $150\ \Omega$ referenced to $400\ \text{kHz}$; unless otherwise specified)

Symbol	Characteristics	Conditions	Min	Typ	Max	Unit
--------	-----------------	------------	-----	-----	-----	------

POWER SUPPLY

V_{CC}	Supply Voltage Range		4.7	5.0	5.3	V
I_{CC}	Supply Current	SD Channels Selected + C_{vbs}		40	55	mA
I_{SD}	Shutdown Current (CVBS_ \overline{EN} and SD_ \overline{EN} High)			42	60	μA

DC PERFORMANCE

V_i	Input Common Mode Voltage Range		GND		1.4	V_{PP}
V_{IL}	Input Low Level for the Control Pins (2, 11)		0		0.8	V
V_{IH}	Input High Level for the Control Pins (2, 11)		2.4		V_{CC}	V
R_{pd}	Pulldown Resistors on Pins CVBS_ \overline{EN} and SD_ \overline{EN}			250		$\text{k}\Omega$

OUTPUT CHARACTERISTICS

V_{OH}	Output Voltage High Level			2.8		V
V_{OL}	Output Voltage Low Level			200		mV

AC ELECTRICAL CHARACTERISTICS FOR STANDARD DEFINITION CHANNELS (pin numbers (1, 14) (5, 10), (6, 9), (7, 8)) ($V_{CC} = +5.0\text{ V}$, $V_{in} = 1\text{ V}_{PP}$, $R_{source} = 37.5\ \Omega$, $T_A = 25^\circ\text{C}$, inputs AC-coupled with $0.1\ \mu\text{F}$, all outputs AC-coupled with $220\ \mu\text{F}$ into $150\ \Omega$ referenced to $400\ \text{kHz}$; unless otherwise specified)

Symbol	Characteristics	Conditions	Min	Typ	Max	Unit
MTH A_{VSD}	Voltage Gain	$V_{in} = 1\text{ V}$ – All SD Channels	5.8	6.0	6.2	dB
BW_{SD}	Low Pass Filter Bandwidth (Note 4)	-1 dB -3 dB	5.5 6.5	7.2 8.0		MHz
A_{RSD}	Stop-band Attenuation (Notes 4 and 5)	@ 27 MHz	43	50		dB
dG_{SD}	Differential Gain Error			0.7		%
$d\Phi_{SD}$	Differential Phase Error			0.7		

NCS2554

TYPICAL CHARACTERISTICS

$V_{CC} = +5.0 \text{ V}$, $V_{in} = 1 \text{ V}_{PP}$, $R_{source} = 37.5 \Omega$

TYPICAL CHARACTERISTICS

$V_{CC} = +5.0\text{ V}$, $V_{in} = 1\text{ V}_{PP}$, $R_{source} = 37.5\ \Omega$, $T_A = 25^\circ\text{C}$, Inputs AC-coupled with $0.1\ \mu\text{F}$, All Outputs AC-coupled with $220\ \mu\text{F}$ into $150\ \Omega$ Referenced to $400\ \text{kHz}$; unless otherwise specified

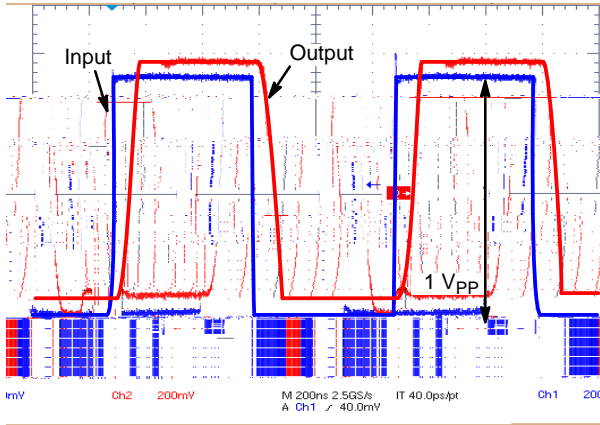

Figure 9. SD Large Signal Response

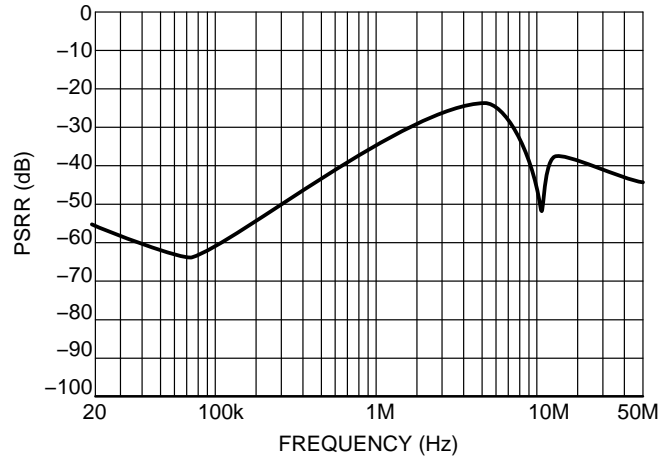

Figure 10. SD V_{CC} PSRR vs. Frequency

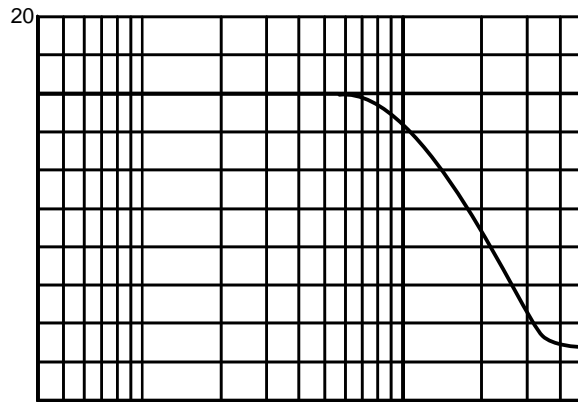

Figure 11. SD Frequency Response and Group Delay

APPLICATIONS INFORMATION

The NCS2554 quad video driver has been optimized for Standard video applications covering the requirements of the standards Composite video (Cvbs), S-Video, Component Video (480i/525i, 576i/625i) and related (RGB). The three SD channels have 8 MHz filters for covering standard definition-like video applications.

In the regular mode of operation each channel provides an internal voltage-to-voltage gain of 2 from input to output. This effectively reduces the number of external components required as compared to discrete approached implemented with stand alone op amps. An internal level shifter is

employed shifting up the output voltage by adding an offset of 200 mV. This prevents sync pulse clipping and allows DC-coupled output to the 150 Ω video load. In addition, the NCS2554 integrates a 6th order Butterworth filter for each. This allows rejection of the aliases or unwanted over-sampling effects produced by the video DAC. Similarly for the case of DVD recorders which use an ADC, this anti-aliasing filter (reconstruction filter) will avoid picture quality issue and will aide filtration of parasitic signals caused by EMI interference.

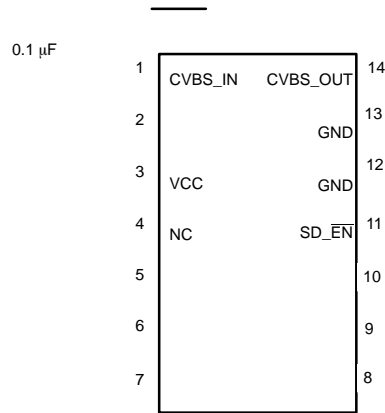
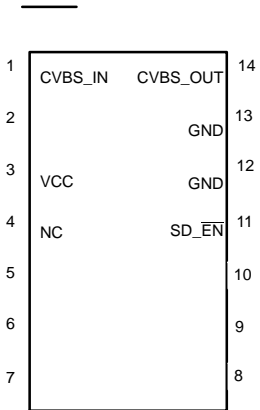

Figure 14. AC-Coupled Configuration at the Input and Output

NCS2554



W



NCS2554

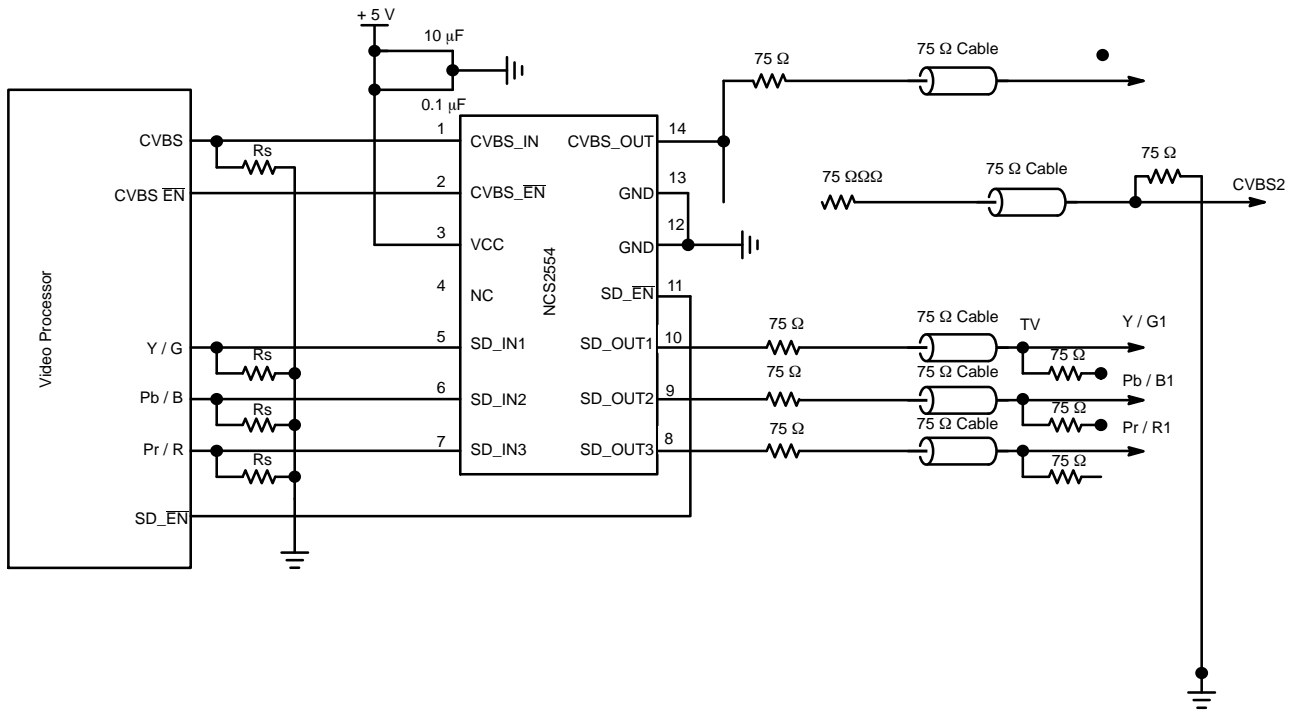

Figure 17. NCS2554 Driving 2 SCARTS Simultaneously

onsemi, **onsemi**, and other names, marks, and brands are registered and/or common law trademarks of Semiconductor Components Industries, LLC dba "**onsemi**" or its affiliates and/or subsidiaries in the United States and/or other countries. **onsemi** owns the rights to a number of patents, trademarks, copyrights, trade secrets, and other intellectual property. A listing of **onsemi**'s product/patent coverage may be accessed at www.onsemi.com/site/pdf/Patent-Marking.pdf. **onsemi** reserves the right to make changes at any time to any products or information herein, without notice. The information herein is provided "as-is" and **onsemi** makes no warranty, representation or guarantee regarding the accuracy of the information, product features, availability, functionality, or suitability of its products for any particular purpose, nor does **onsemi** assume any liability arising out of the application or use of any product or circuit, and specifically disclaims any and all liability, including without limitation special, consequential or incidental damages. Buyer is responsible for its products and applications using **onsemi**
