

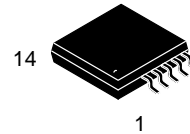

<http://onsemi.com>



**TSSOP-14
TBD SUFFIX
CASE 948G**

**MARKING
DIAGRAM**

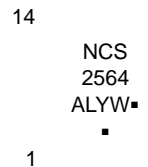

NCS2564 = Specific Device Code
 A = Assembly Location
 L = Wafer Lot
 Y = Year
 W = Work Week
 ■ = Pb-Free Package

PINOUT

CVBS_IN	1	14	CVBS_OUT
CVBS_EN	2	13	GND
VCC	3	12	GND
SD/HD	4	11	SD/HD_EN
SD/HD_IN1	5	10	SD/HD_OUT1
SD/HD_IN2	6	9	SD/HD_OUT2
SD/HD_IN3	7	8	SD/HD_OUT3

(Top View)

ORDERING INFORMATION

Device	Package	Shipping†
NCS2564DTBR2G	TSSOP-14 (Pb-Free)	2500 / Tape & Reel

†For information on tape and reel specifications, including part orientation and tape sizes, please refer to our Tape and Reel Packaging Specifications Brochure, BRD8011/D.

-
-
-
-
-
-
-
-
-
-
-

Typical Application

-
-
-

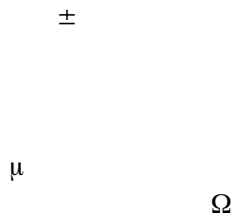

NCS2564

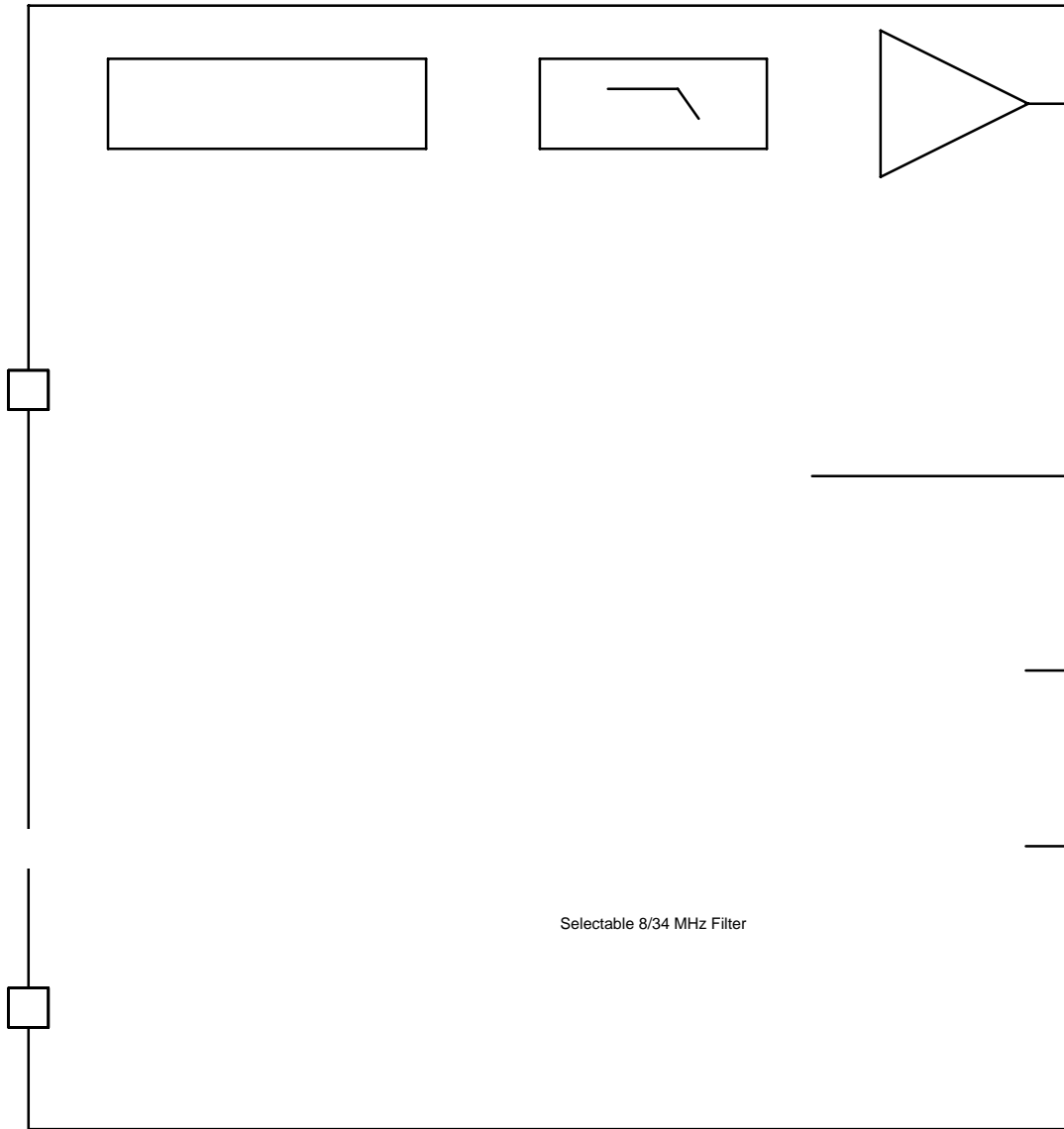

Selectable 8/34 MHz Filter

NCS2564

PIN DESCRIPTION

Pin No.	Name	Type	Description
1	CVBS_IN	Input	Video Input for Video Signal featuring a frequency bandwidth compatible with NTSC / PAL / SECAM Video (8 MHz) – CVBS Channel
2	CVBS_EN	Input	CVBS Channel Enable /Disable Function: Low = Enable, High = Disable. When left open the default state is Enable.
3	VCC	Power	Power Supply / 4.7 V to 5.3 V
4	$\overline{SD/HD}$	Input	Pin of selection enabling the Standard Definition or High Definition Filters (8 MHz / 34 MHz) for channels SD/HD – when Low SD filters are selected, when High HD filters are selected.
5	SD/HD_IN1	Input	Selectable SD or HD Video Input 1 – SD/HD Channel 1
6	SD/HD_IN2	Input	Selectable SD or HD Video Input 2 – SD/HD Channel 2
7	SD/HD_IN3	Input	Selectable SD or HD Video Input 3 – SD/HD Channel 3
8	SD/HD_OUT3	Output	SD/HD Video Output 3 – SD/HD Channel 3
9	SD/HD_OUT2	Output	SD/HD Video Output 2 – SD/HD Channel 2
10	SD/HD_OUT1	Output	SD/HD Video Output 1 – SD/HD Channel 1
11	SD/HD_EN	Input	SD/HD Channel Enable/Disable Function: Low = Enable, High = Disable. When left open the default state is Enable.
12	GND	Ground	Ground
13	GND	Ground	Ground
14	CVBS_OUT	Output	CVBS Video Output – CVBS Channel

NCS2564

MAXIMUM RATINGS

Rating	Symbol	Value	Unit
Power Supply Voltages	V_{CC}	$-0.3 \leq V_{CC} \leq 5.5$	Vdc
I/O Voltage Range	V_{IO}	$-0.3 \leq V_I \leq V_{CC}$	Vdc
Input Differential Voltage Range	V_{ID}	$-0.3 \leq V_I \leq V_{CC}$	Vdc
Output Current (Indefinitely) per Channel	I_O	40	mA
Maximum Junction Temperature (Note 1)	T_J	150	

NCS2564

DC ELECTRICAL CHARACTERISTICS ($V_{CC} = +5.0\text{ V}$, $R_{source} = 37.5\ \Omega$, $T_A = 25^\circ\text{C}$, inputs AC-coupled with $0.1\ \mu\text{F}$, all outputs AC-coupled with $220\ \mu\text{F}$ into $150\ \Omega$ referenced to $400\ \text{kHz}$; unless otherwise specified)

Symbol	Characteristics	Conditions	Min	Typ	Max	Unit
POWER SUPPLY						
V_{CC}	Supply Voltage Range		4.7	5.0	5.3	V
I_{CC}	Supply Current	SD Channels Selected + C_{vbs} HD Channels Selected + C_{vbs}		40 50	55 70	mA
I_{SD}	Shutdown Current (CVBS_EN and SD/H10.81-0 Se06.306 636.831 11.112 .34015 refBT8		0.71	2.76	4.57	mA

NCS2564

AC ELECTRICAL CHARACTERISTICS FOR HIGH DEFINITION CHANNELS (pin numbers (5, 10) (6, 9), (7, 8))

($V_{CC} = +5.0\text{ V}$, $V_{in} = 1\text{ V}_{PP}$, $R_{source} = 37.5\ \Omega$, $T_A = 25^\circ\text{C}$, inputs AC-coupled with $0.1\ \mu\text{F}$, all outputs AC-coupled with $220\ \mu\text{F}$ into $150\ \Omega$ referenced to 400 kHz ; unless otherwise specified, $\overline{SD}/HD = \text{High}$)

Symbol	Characteristics	Conditions	Min	Typ	Max	Unit
A_{VHD}	Voltage Gain	$V_{in} = 1\text{ V}$ – All HD Channels	5.8	6.0	6.2	dB
BW_{HD}	Low Pass Filter Bandwidth	-1 dB (Note 6) -3 dB (Note 7)	26 30	31 34		MHz
A_{RHD}		MdB (Note 7)MdB (Not6 7)				dB

TYPICAL CHARACTERISTICS

$V_{CC} = +5.0\text{ V}$, $V_{in} = 1\text{ V}_{PP}$, $R_{source} = 37.5\ \Omega$, $T_A = 25^\circ\text{C}$, Inputs AC-coupled with $0.1\ \mu\text{F}$, All Outputs AC-coupled with $220\ \mu\text{F}$ into $150\ \Omega$
 Referenced to 400 kHz; unless otherwise specified

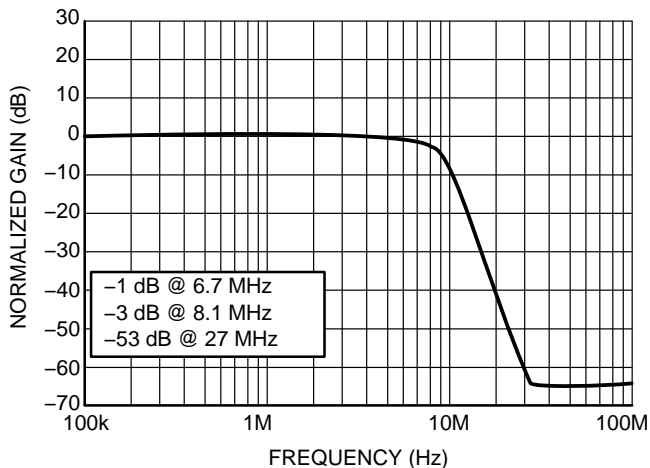

Figure 3. SD Normalized Frequency Response

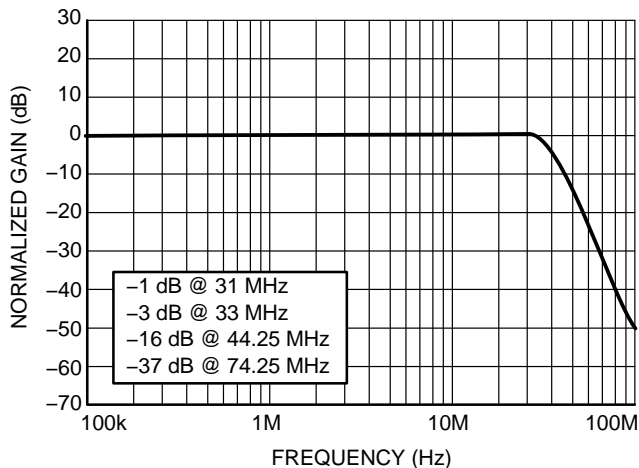

Figure 4. HD Normalized Frequency Response

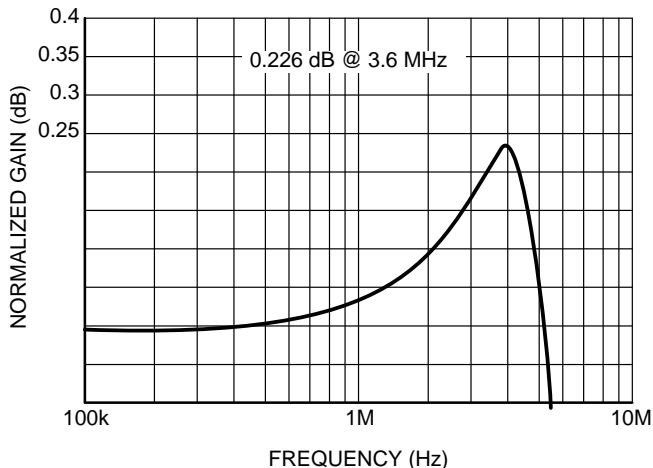
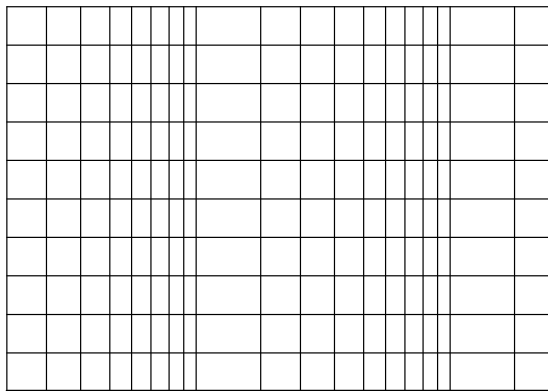

Figure 5. SD Passband Flatness



NCS2564

TYPICAL CHARACTERISTICS

$V_{CC} = +5.0\text{ V}$, $V_{in} = 1\text{ V}_{PP}$, $R_{source} = 37.5\ \Omega$, $T_A = 25^\circ\text{C}$, Inputs AC-coupled with $0.1\ \mu\text{F}$, All Outputs AC-coupled with $220\ \mu\text{F}$ into $150\ \Omega$
 Referred to 400 kHz; unless otherwise specified

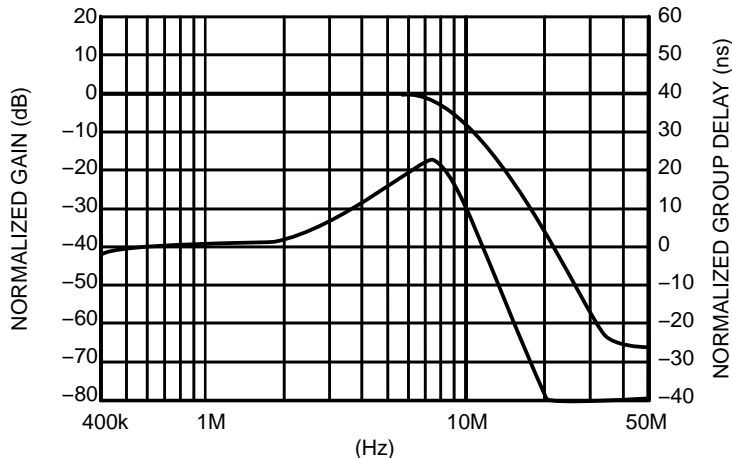

Figure 18. SD Frequency Response and Group Delay

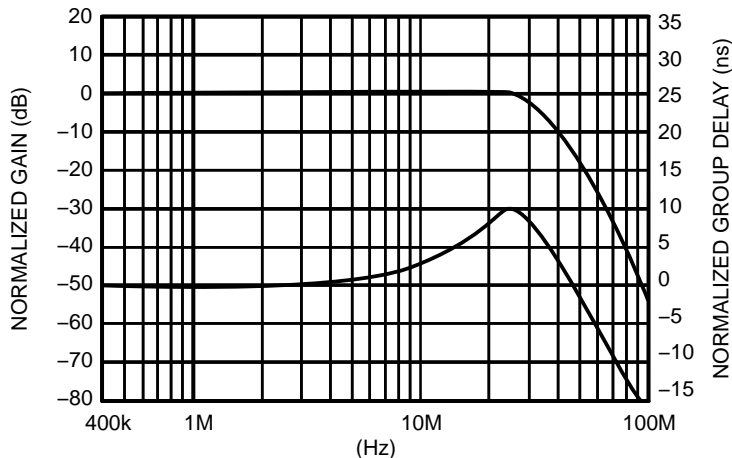

Figure 19. HD Frequency Response and Group Delay

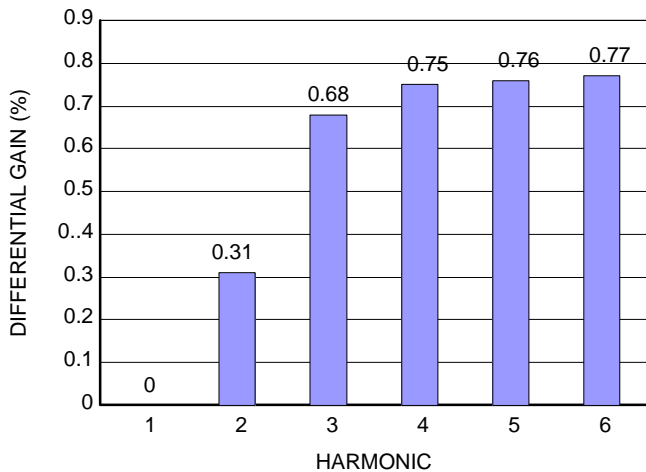

Figure 20. SD Differential Gain

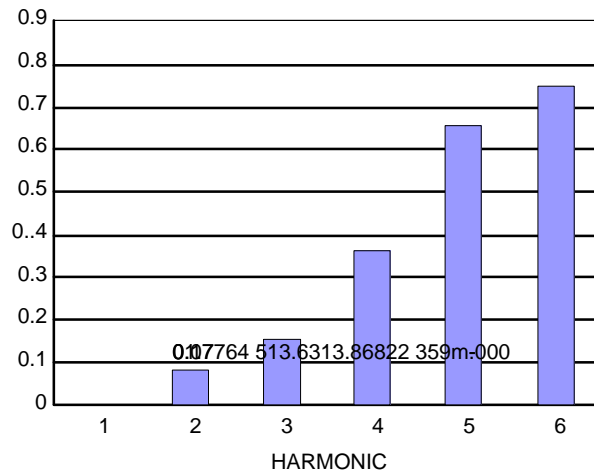

Figure 21. SD Differential Phase

NCS2564

APPLICATIONS INFORMATION

Ω

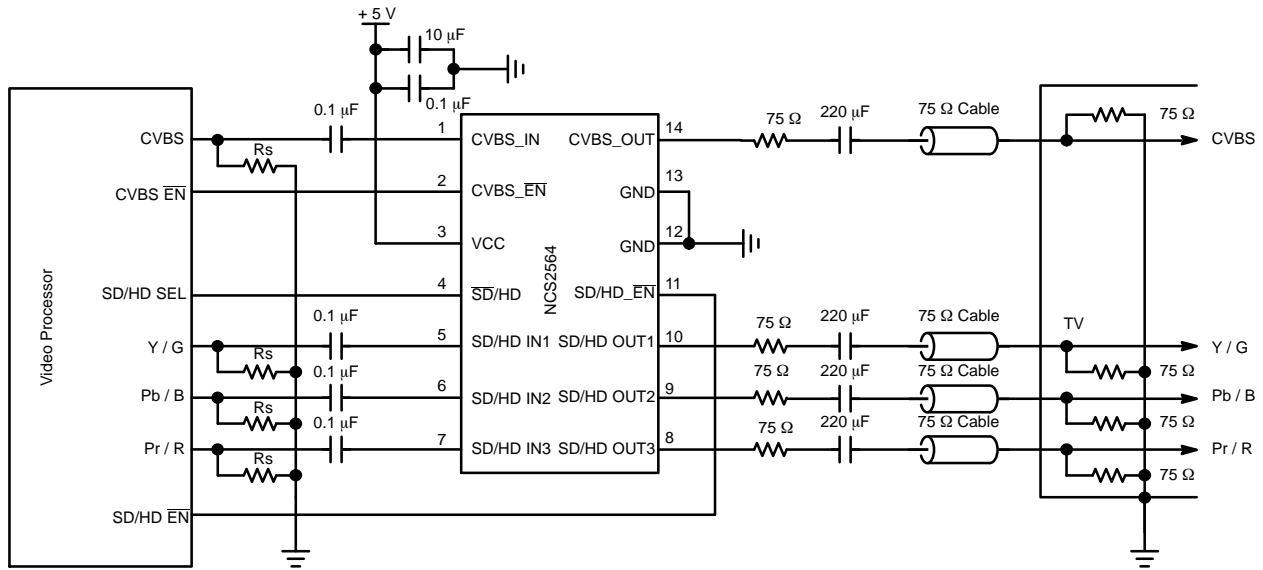

Figure 22. AC-Coupled Configuration at the Input and Output

μ

μ

Ω

NCS2564

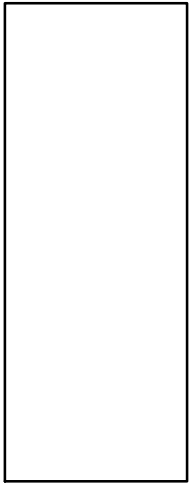

—

1	CVBS_IN	CVBS_OUT	14
2		GND	13
3	VCC	GND	12
4	SD/HD	SD/HD_EN	11
5			10
6			9
7			8

NCS2564

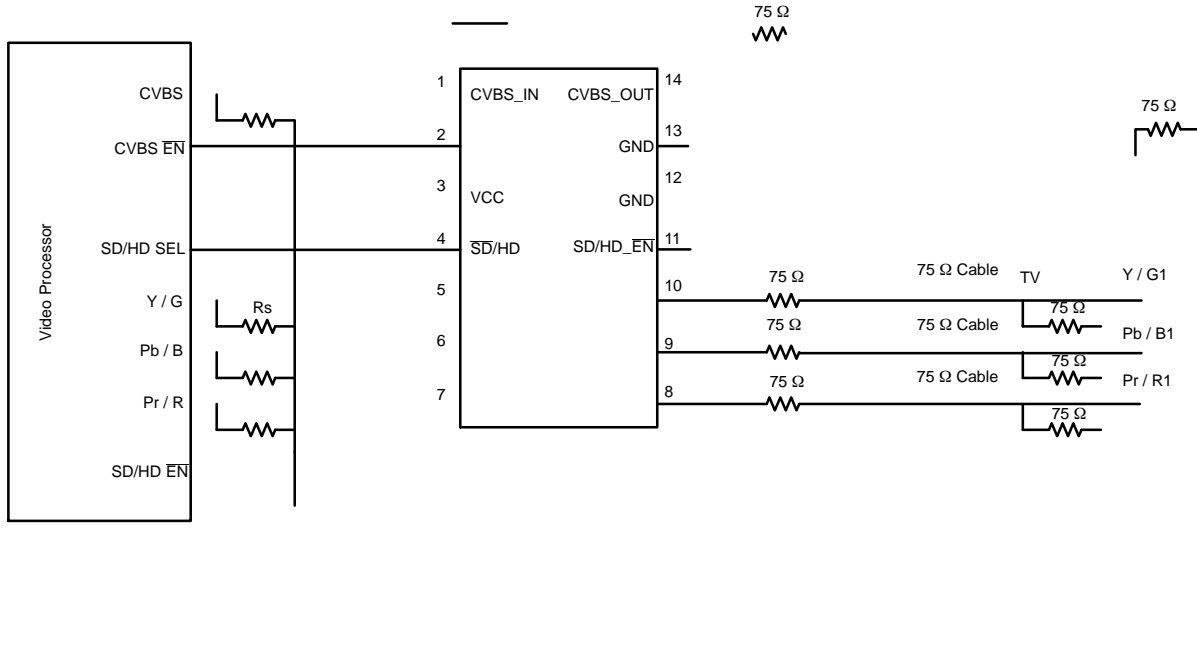

NCS2564

Video Driving Capability

ESD Protection

Ω

onsemi, **onsemi**, and other names, marks, and brands are registered and/or common law trademarks of Semiconductor Components Industries, LLC dba "**onsemi**" or its affiliates and/or subsidiaries in the United States and/or other countries. **onsemi** owns the rights to a number of patents, trademarks, copyrights, trade secrets, and other intellectual property. A listing of **onsemi**'s product/patent coverage may be accessed at www.onsemi.com/site/pdf/Patent-Marking.pdf. **onsemi** reserves the right to make changes at any time to any products or information herein, without notice. The information herein is provided "as-is" and **onsemi** makes no warranty, representation or guarantee regarding the accuracy of the information, product features, availability, functionality, or suitability of its products for any particular purpose, nor does **onsemi** assume any liability arising out of the application or use of any product or circuit, and specifically disclaims any and all liability, including without limitation special, consequential or incidental damages. Buyer is responsible for its products and applications using **onsemi**
